



# USER MANUAL

## LVTS-512100-G3 LFP Battery

## Contents

1 Product Overview .....	1
1.1 Appearance .....	1
1.2 Switch, LCD, LED & Communication Port .....	2
1.2.1 Switch ON/OFF .....	2
1.2.2 Color touchscreen .....	2
1.2.3 Communication Port Definition .....	5
2 Installation Guide .....	6
2.1 Checking Deliverables .....	6
2.2 Tools .....	7
2.3 Installation Instructions .....	8
2.3.1 Installation Step (Floor Mounted) .....	9
2.3.2 Installation Step (Wall Mounted) .....	9
3 Technical Specifications .....	13
4 Maintenance .....	14
4.1 Recharge Requirements During Storage .....	14
4.2 Recharge Requirements When Over Discharged .....	14

# 1 Product Overview

LVTS-512100-G3 is a 51.2V 100Ah Lithium battery that can be wall mounted or floor mounted.

Note: LVTS-512100-G3 is **NOT** suitable for life-sustaining medical devices.

## 1.1 Appearance

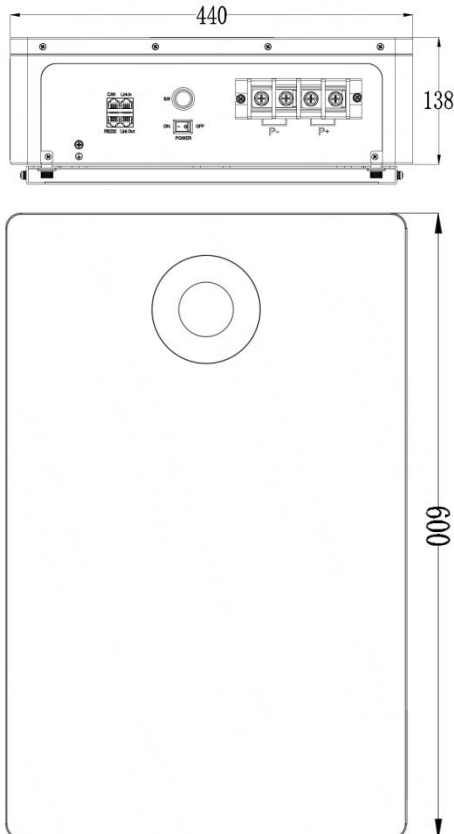

## 1.2 Switch, LCD, LED & Communication Port

### 1.2.1 Switch ON/OFF

#### 1、Switch ON

For single LVTS-512100-G3, switch ON POWER button, then long press (3 sec) SW button.

For multiple LVTS-512100-G3 connected in parallel, switch ON POWER buttons of all batteries, then long press (3 sec) SW button of master battery.

#### 2、Switch OFF

Switch OFF POWER button(s) of all batteries.

### 1.2.2 Color touchscreen

1) Swipe the screen to see “SN Info”, “Capacity Info”, “Temp Info”, “Cell Voltage”, “Current Event”, “History Event”, “Set Protocol” & “Display Time”.

2) If current protocol is incorrect, tap “CAN” checkbox and select correct protocol.

3) If current time is incorrect, tap “Set Time” button and change time then tap “Save” button.





### SN Info

VER : P16S200A-41123-1.01G  
PACK: AS001007080424010001  
BMS : 315301540300781D

### Capacity Info

Capacity: 200AH  
SOH: 100%  
SOC: 50%  
Cycle: 0

### Temp Info

T1: 25.0 °C    T3: 25.0 °C  
T2: 25.0 °C    T4: 25.0 °C  
T\_MOS: 25.0 °C  
T\_ENV: 25.0 °C

### Cell Volatge

01: 3200mV	09: 3200mV
02: 3200mV	10: 3200mV
03: 3200mV	11: 3200mV
04: 3200mV	12: 3200mV
05: 3200mV	13: 3200mV
06: 3200mV	14: 3200mV
07: 3200mV	15: 3200mV
08: 3200mV	16: 3200mV

51.2V    0A

### Current Event

Alarm: None  
Protect: None  
Fault: None

### History Event

001 04.29 12:00 p0VW ▲





<h3>Set Protocol</h3> <p>PYLON CAN <input checked="" type="checkbox"/></p> <p>RS485 <input checked="" type="checkbox"/></p>	<h3>Set Protocol</h3> <p>01:PYLON <input checked="" type="checkbox"/></p> <p>02:GROWATT <input type="checkbox"/></p> <p>03:VICTRON <input type="checkbox"/></p> <p>04:SMA <input type="checkbox"/></p> <p>05:MUST <input type="checkbox"/></p> <p>06SOFAR <input type="checkbox"/></p>
<h3>Display Time</h3> <p>2024 - 4 - 29 12:00</p> <p><input type="button" value="Set Time"/></p>	<h3>Set Time</h3> <p>2024 - 4 - 29 12:00</p> <p><input type="button" value="Save"/> <input type="button" value="Cancel"/></p>

## 1.2.3 Communication Port Definition

### 1.2.3.1 CAN/RS485 to PCS

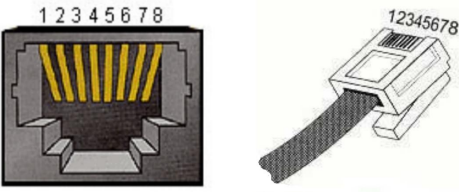
Port definitions	RJ45 Pin	Function
	1	RS485-B
	2	RS485-A
	3	GND
	4	CAN-H
	5	CAN-L
	6	NC
	7	RS485-A
	8	RS485-B



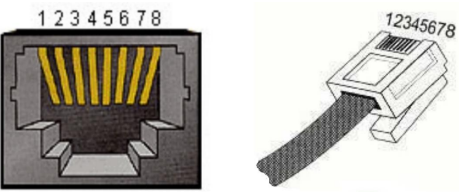

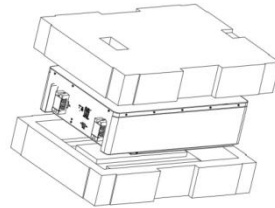
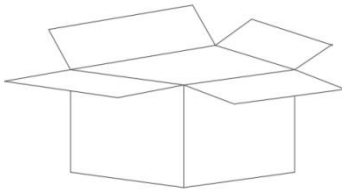

### 1.2.3.2 RS232 to PC

Port definitions	RJ45 Pin	Function
	1	RS232-TX
	2	GND
	3	RS232-RX
	4	NC
	5	NC
	6	NC
	7	NC
	8	NC



## 2 Installation Guide

### 2.1 Checking Deliverables







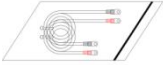
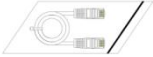
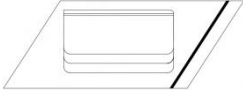

NO.	Pictures	Quantity	Description
1		1 pc	Battery
2		6 pcs	Battery hanging bolt
3		6 pcs	Battery hanger
4		1 pc	Wall Mount
5		2 pcs	Wall Mount Bottom Bolt
6		6 pcs	Expansion Bolt

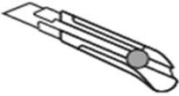

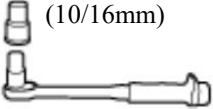
7		1 pc	cover
8		2 pcs	Cover bolt
9		1 pair	Power cable
10		1 pc	Comm cable
11		1 pc	User Manual

## 2.2 Tools

Tools			
Installation	Knife 	Measuring tape 	Socket wrench (10/16mm) 
	Hammer 	Cross Screwdriver 	Hammer drill 

Protection	ESD gloves 	Safety goggles 	Safety Shoes 
------------	---	---	---

### 2.3 Installation Instructions

Minimum mounting distance requirement: (Wall Mounted)

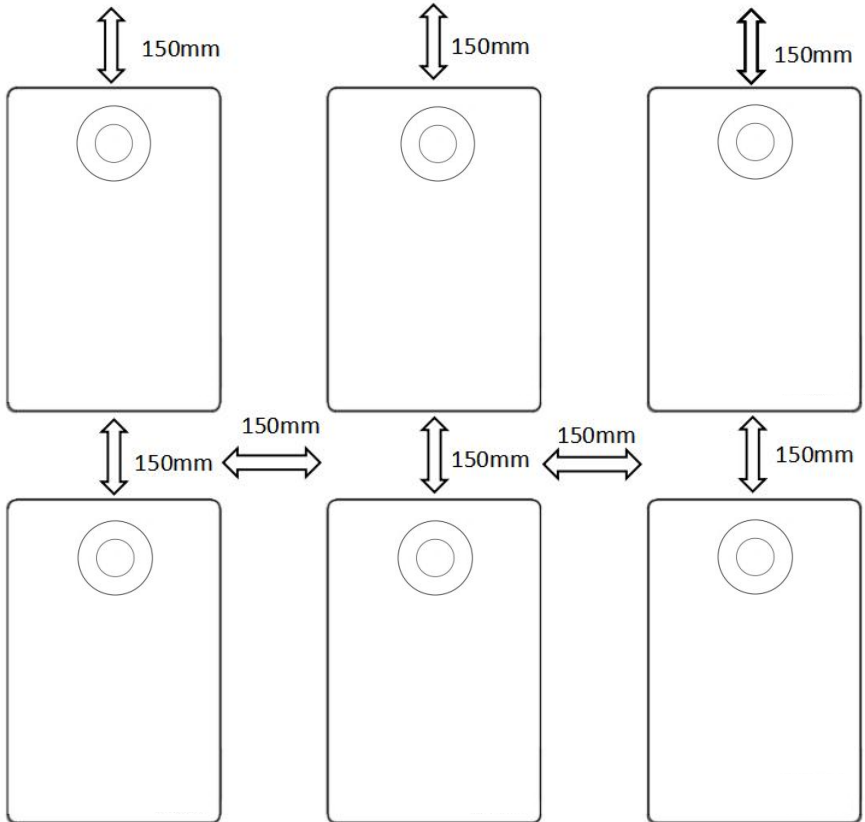



### 2.3.1 Installation Step (Floor Mounted)

#### Step 1

put LVTS-512100-G3 on floor then start from Step 7

### 2.3.2 Installation Step (Wall Mounted)

#### Step 1

Remove 2 pcs wall mount bottom bolts,  
remove wall mount from battery.

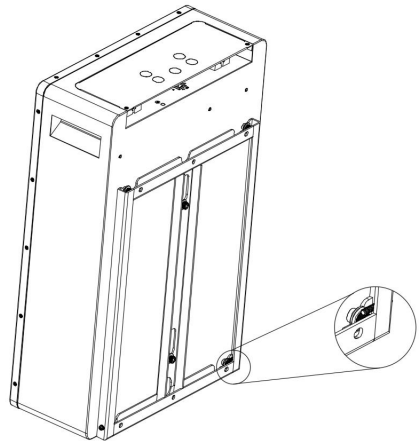

#### Step 2

Drill holes in the wall  
according to wall mount.



**Step 3**

Fix wall mount to the wall using expansion bolt.

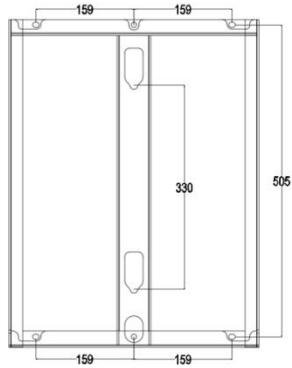
**Step 4**

Hang LVTS-512100-G3 battery on wall mount.

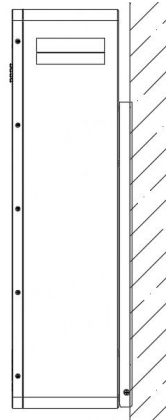
**Step 5**

Install 2 pcs wall mount bottom bolts.

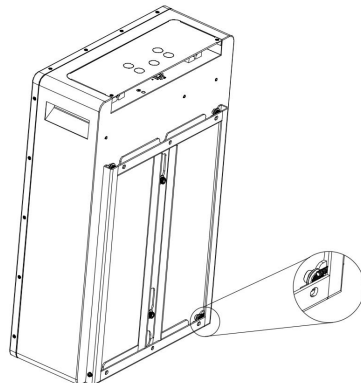

**Step 6**

remove levelling feet.

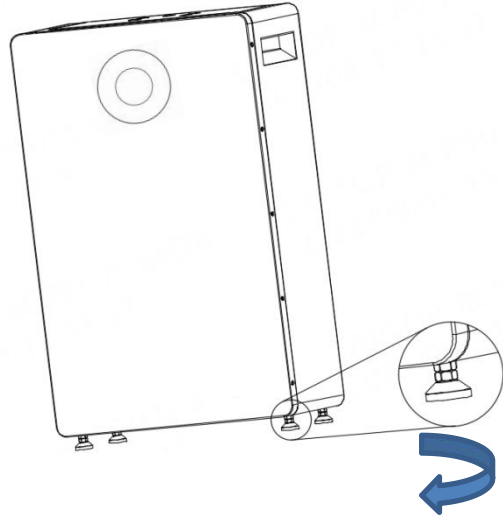

**Step 7** Connect PE cable & power cable.

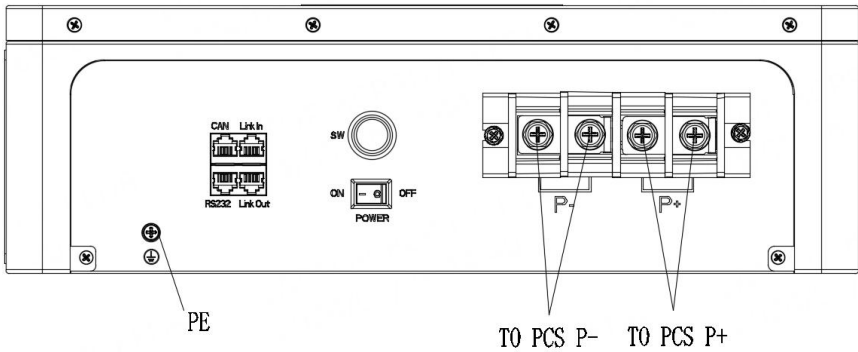

**Step 8** Connect communication cable.

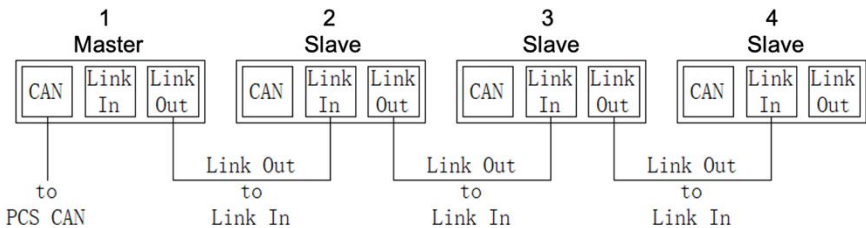

**Step 9** Refer to the following diagram when multiple batteries are connected in parallel:

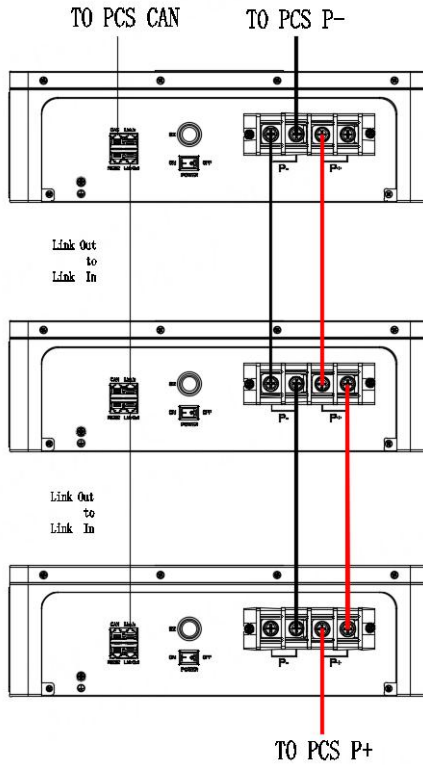

**Step 10** Install cover using cover bolts.

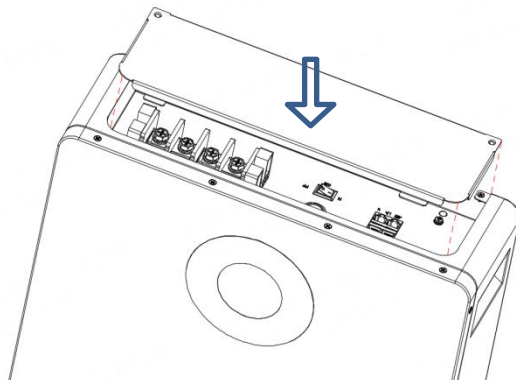

### 3 Technical Specifications

Basic Project		Parameter
Nominal Voltage		51.2V
Nominal Capacity		100Ah
Nominal Energy		5120Wh
Charge Voltage		56.16V
Charge Current		50A
Discharge Voltage Range		45.6V~56.16V
Discharge Current		100A
Communication Mode		CAN/RS485
Working Temperature	Charge	0°C~55°C
	Discharge	-20°C~55°C
Storage Temperature	Short Term (within 1 month)	-10°C~45°C
	Long Term (within 1 year)	0°C~35°C
Storage Humidity		<95% RH
Cell Type		LiFePO <sub>4</sub> , Lithium Iron Phosphate
Size		H600*W440*D138(mm)
Weight		47.2KG (Wall Bracket Included)
IP Level		IP21

## 4 Maintenance

### 4.1 Recharge Requirements During Storage

Batteries should be stored in temperature between  $-10^{\circ}\text{C} \sim +45^{\circ}\text{C}$ , and recharged regularly according to the following table with 0.2C (20A) current to 50% SOC after long time storage.

**Recharge requirement during storage**

Storage Temperature	Storage Relative Humidity	Storage Time	SOC
Below $-10^{\circ}\text{C}$	/	Not Allowed	/
$-10\sim 0^{\circ}\text{C}$	5%~70%	$\leq 1$ months	$30\% \leq \text{SOC} \leq 60\%$
$0\sim 25^{\circ}\text{C}$	5%~70%	$\leq 12$ months	$30\% \leq \text{SOC} \leq 60\%$
$25\sim 35^{\circ}\text{C}$	5%~70%	$\leq 6$ months	$30\% \leq \text{SOC} \leq 60\%$
$35\sim 45^{\circ}\text{C}$	5%~70%	$\leq 1$ months	$30\% \leq \text{SOC} \leq 60\%$
Above $45^{\circ}\text{C}$	/	Not Allowed	/

### 4.2 Recharge Requirements When Over Discharged

Please recharge over discharged (90% DOD) batteries according to the following table, otherwise over discharged battery will be damaged.

**Recharge requirement when battery is over discharged**

Storage Temperature	Storage Time	Note
$-10\sim 25^{\circ}\text{C}$	$\leq 15$ days	Battery disconnected from PCS
$25\sim 45^{\circ}\text{C}$	$\leq 7$ days	
$-10\sim 45^{\circ}\text{C}$	< 12 hours	Battery connected to PCS

**Attention: Disposal of batteries should follow local regulations.**