

USER MANUAL

LVTS-512200 Lithium Battery



Contents

1 Product Overview	1
1.1 Appearance	1
1.2 Switch, LCD, LED & Communication Port	2
1.2.1 DIP Switch	2
1.2.2 Switch ON/OFF	3
1.2.3 LCD Display	3
1.2.4 LED Definition	4
1.2.5 Communication Port Pin Definition	6
2 Installation Guide	7
2.1 Checking Deliverables	7
2.2 Tools	8
2.3 Installation Instructions	9
2.3.1 Installation Step	10
3 Technical Specifications	14
4 Maintenance	15
4.1 Recharge Requirements During Storage	15
4.2 Recharge Requirements When Over Discharged	15

1 Product Overview

LVTS-512200 is a 51.2V 200Ah Lithium battery that can be wall mounted or floor mounted.

Note: LVTS-512200 is **NOT** suitable for life-sustaining medical devices.

1.1 Appearance

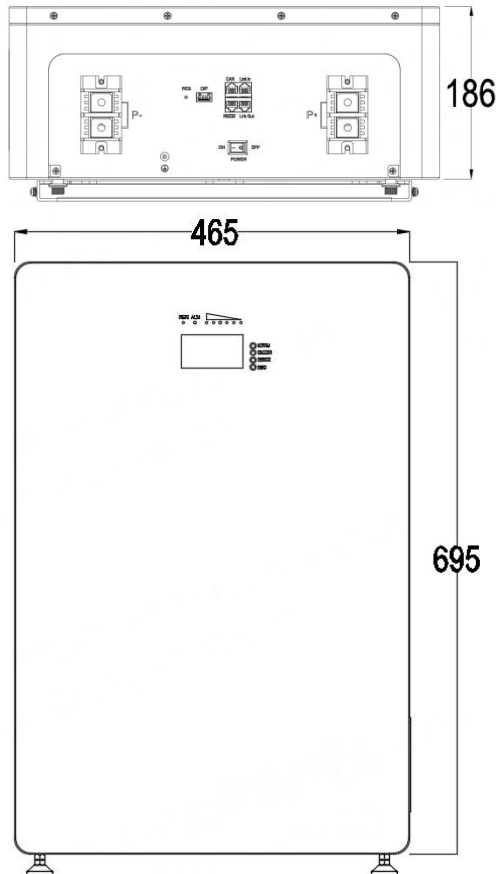

1.2 Switch, LCD, LED & Communication Port

1.2.1 DIP Switch

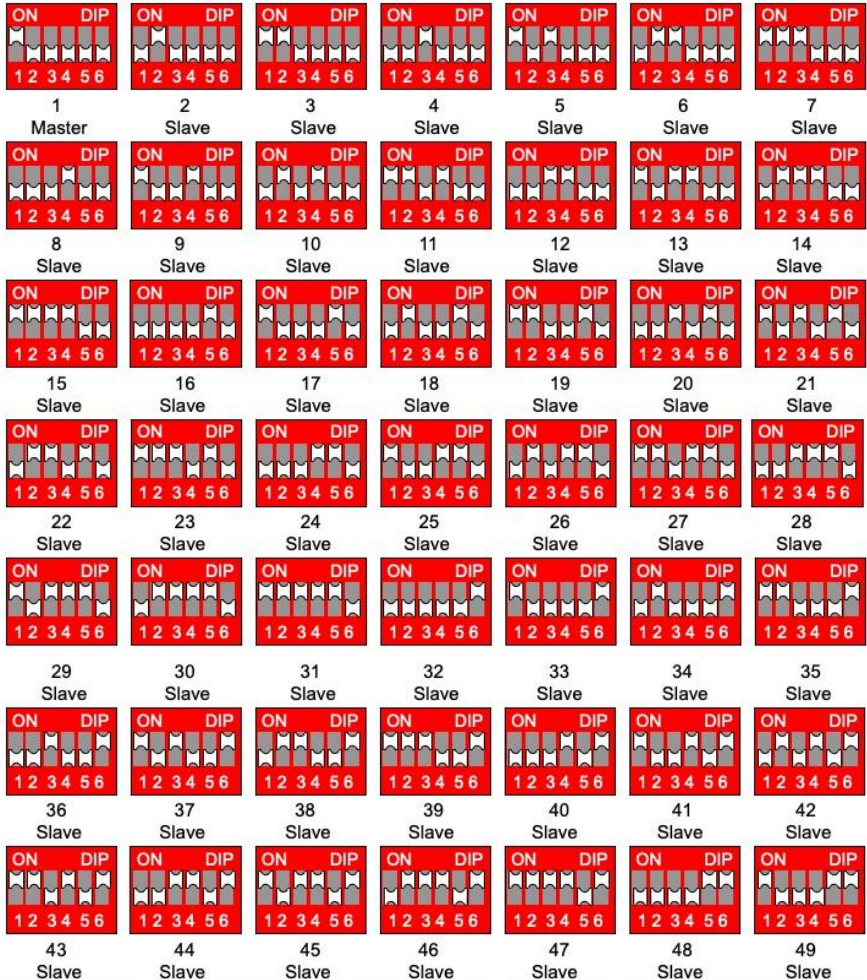

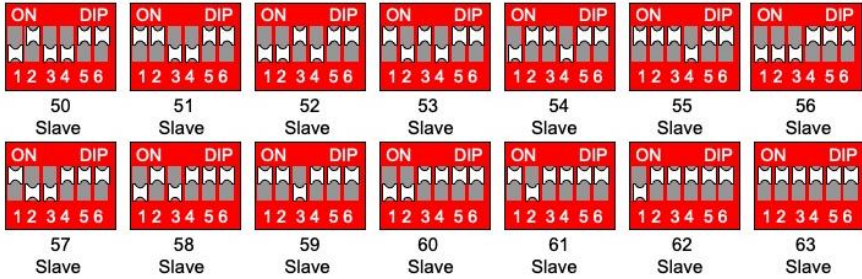

1.2.2 Switch ON/OFF

1、 Switch ON

For single LVTS-512200, set DIP switch to 1, then switch ON POWER button.

For multiple LVTS-512200 connected in parallel, set DIP switch according to 1.2.1, then switch ON POWER buttons of all batteries.

2、 Switch OFF

Switch OFF POWER button(s) of all batteries.

1.2.3 LCD Display

Press “MENU” button to main menu page.

Press “ESC” button to return to previous menu.

Every line is started with “>>” or “--”, “>>” is the current cursor.

Press “DOWN” button to move cursor.

If a line is ended with “>>”, you can press “ENTER” button to see more information.

If you don’t press any button, LCD display will switch OFF after 1 min to save energy. You can press any button to switch ON LCD display.

1.2.4 LED Definition

Note: Flash 1 - 0.25s ON / 3.75s OFF

Flash 2 - 0.5s ON / 0.5s OFF

Flash 3 - 0.5s ON / 1.5s OFF

SOC Status while charging

STATUS		CHARGE							
		L8 ●	L7 ●	L6 ●	L5 ●	L4 ●	L3 ●	L2 ●	L1 ●
SOC (%)	0~17	ON	OFF	OFF	OFF	OFF	OFF	OFF	Flash 2
	18~33			OFF	OFF	OFF	OFF	Flash 2	ON
	34~50			OFF	OFF	OFF	Flash 2	ON	ON
	51~66			OFF	OFF	Flash 2	ON	ON	ON
	67~83			OFF	Flash 2	ON	ON	ON	ON
	84~100			Flash 2	ON	ON	ON	ON	ON

SOC Status while discharging

STATUS		DISCHARGE							
		L8 ●	L7 ●	L6 ●	L5 ●	L4 ●	L3 ●	L2 ●	L1 ●
SOC (%)	0~17	Flash 3	OFF	OFF	OFF	OFF	OFF	OFF	ON
	18~33			OFF	OFF	OFF	OFF	ON	ON
	34~50			OFF	OFF	OFF	ON	ON	ON
	51~66			OFF	OFF	ON	ON	ON	ON
	67~83			OFF	ON	ON	ON	ON	ON
	84~100			ON	ON	ON	ON	ON	ON

Work Status

STATUS	RUN	ALM	SOC							DESCRIPTION	
	L8 ●	L7 ●	L6 ●	L5 ●	L4 ●	L3 ●	L2 ●	L1 ●			
Shutdown	OFF	OFF	OFF	OFF	OFF	OFF	OFF	OFF	OFF		
Standby	Flash 1	OFF	According to SOC								
Charge	Normal	ON	OFF	According to SOC							
	Over volt	ON	OFF	ON	ON	ON	ON	ON	ON	ON	Switch to standby mode
	Protection	OFF	ON	OFF	OFF	OFF	OFF	OFF	OFF	OFF	Stop charging
Discharge	Normal	Flash 3	OFF	According to SOC							
	Under volt	OFF	OFF	OFF	OFF	OFF	OFF	OFF	OFF	OFF	Stop discharging
	Protection	OFF	ON	OFF	OFF	OFF	OFF	OFF	OFF	OFF	Stop discharging
Faulty	OFF	ON	OFF	OFF	OFF	OFF	OFF	OFF	OFF	Stop charging and discharging	

1.2.5 Communication Port Definition

1.2.5.1 CAN/RS485 to PCS

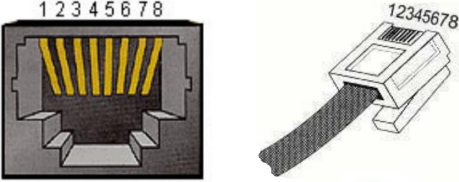
Port definitions	RJ45 Pin	Function
	1	RS485-B
	2	RS485-A
	3	GND
	4	CAN-H
	5	CAN-L
	6	NC
	7	RS485-A
	8	RS485-B



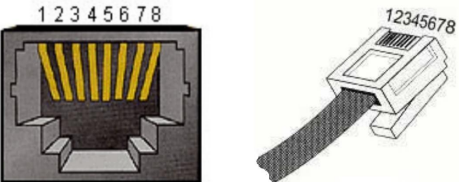

1.2.5.2 RS232 to PC



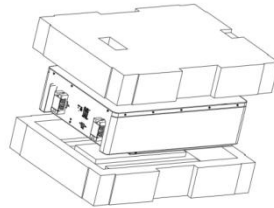
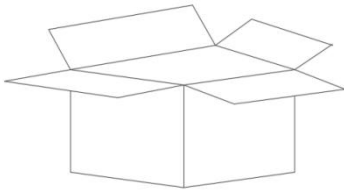

Port definitions	RJ45 Pin	Function
	1	RS232-TX
	2	GND
	3	RS232-RX
	4	NC
	5	NC
	6	NC
	7	NC
	8	NC

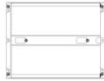
2 Installation Guide





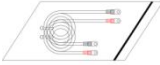
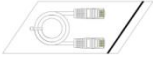

2.1 Checking Deliverables

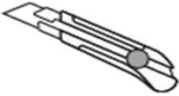

NO.	Pictures	Quantity	Description
1		1 pc	Battery
2		6 pcs	Battery hanging bolt
3		6 pcs	Battery hanger
4		1 pc	Wall Mount
5		2 pcs	Wall Mount Bottom Bolt
6		6 pcs	Expansion Bolt

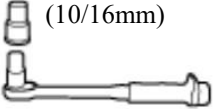
7		1 pc	cover
8		2 pcs	Cover bolt
9		1 pair	Power cable
10		1 pc	Comm cable
11		1 pc	Instruction book

2.2 Tools

Tools			
Installation	Knife 	Measuring tape 	Socket wrench (10/16mm) 
	Hammer 	Cross Screwdriver 	Hammer drill 

Protection	ESD gloves 	Safety goggles 	Safety Shoes 
------------	---	---	---

2.3 Installation Instructions

Minimum mounting distance requirement: (Wall Mounted)

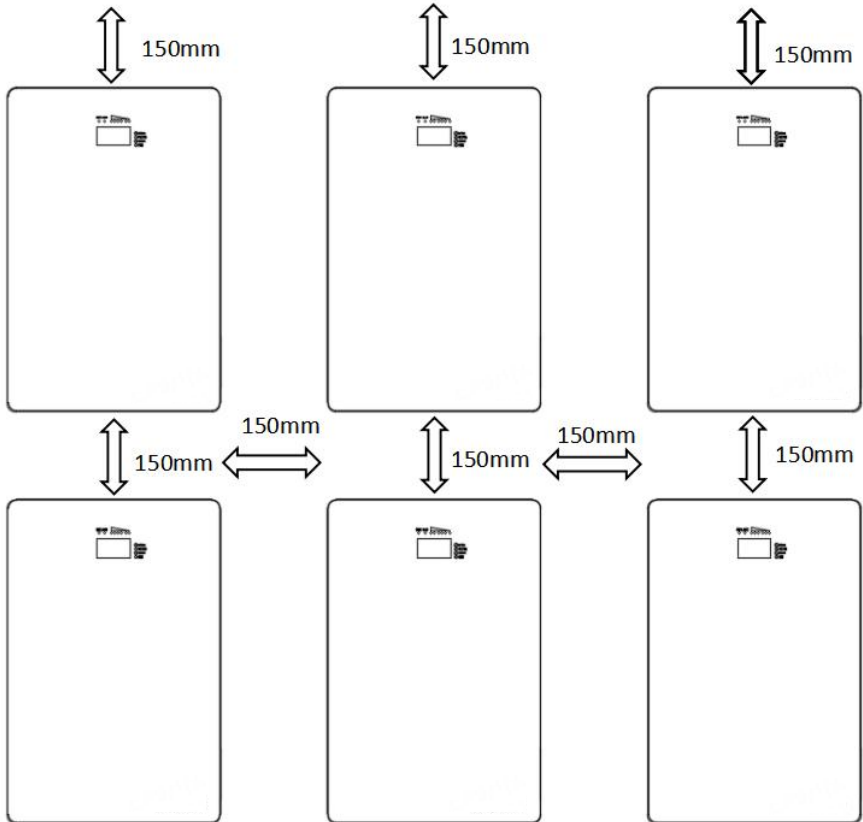

2.3.1 Installation Step (Floor Mounted)

Step 1

put LVTS-512200 on floor then start from Step 7

2.3.2 Installation Step (Wall Mounted)

Step 1

Remove 2 pcs wall mount bottom bolts,
remove wall mount from battery.

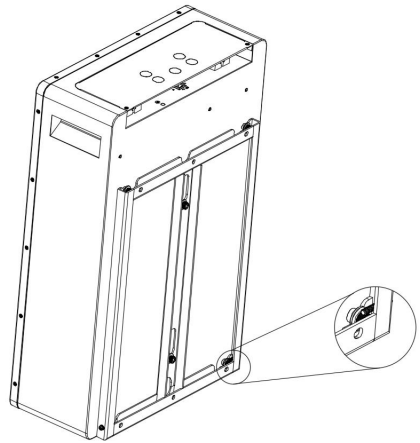

Step 2

Drill holes in the wall
according to wall mount.



Step 3

Fix wall mount to the wall using expansion bolt.

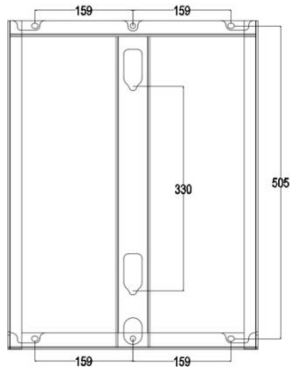
**Step 4**

Hang LVTS-512200 battery on wall mount.

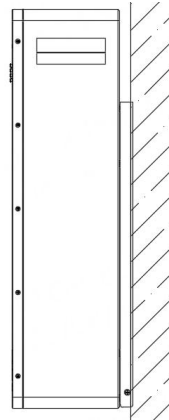
**Step 5**

Install 2 pcs wall mount bottom bolts.

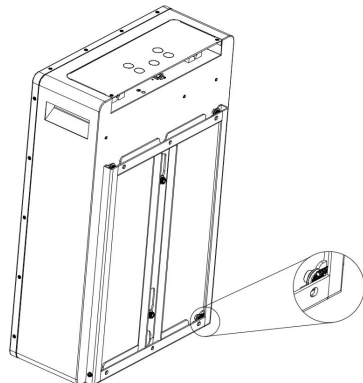

Step 6

remove levelling feet.

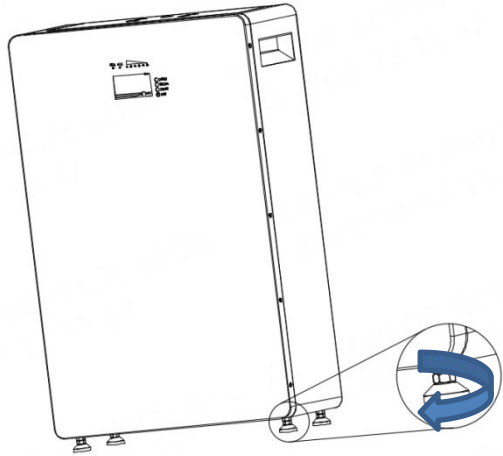

Step 7 Connect PE cable & power cable.

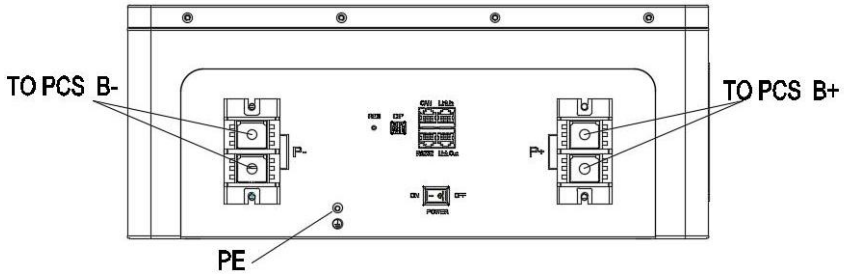

Step 8 Connect communication cable.

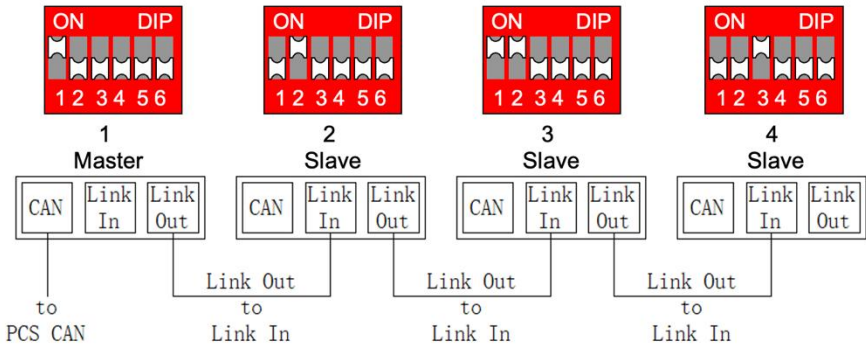

Step 9 Refer to the following diagram when multiple batteries are connected in parallel:

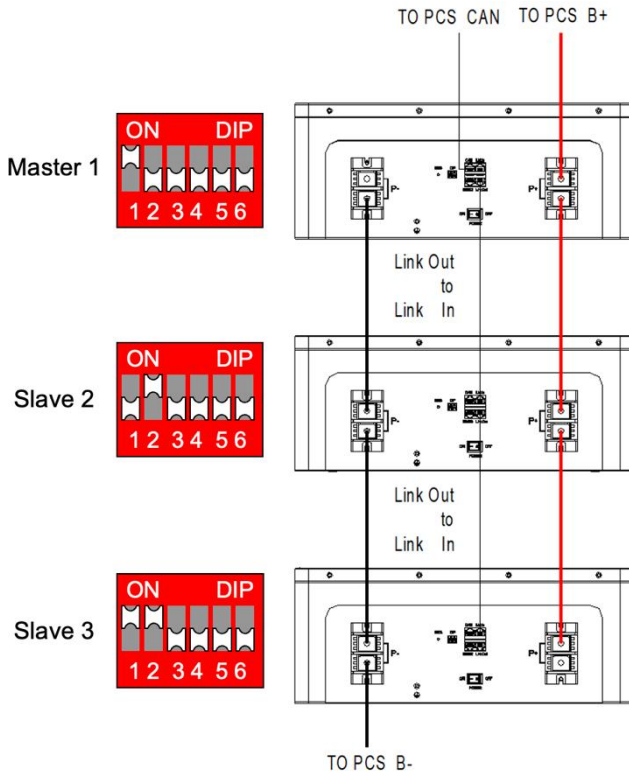

Step 10 Install cover using cover bolts.

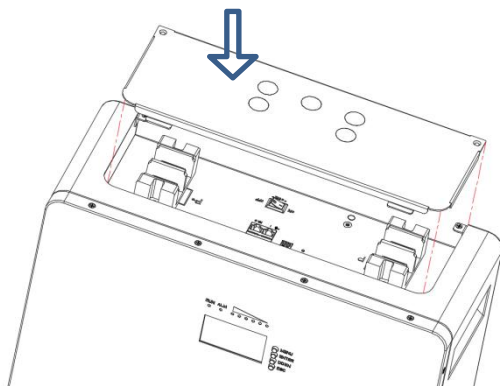

3 Technical Specifications

Basic Project		Parameter
Nominal Voltage		51.2V
Nominal Capacity		200Ah
Nominal Energy		10240Wh
Charge Voltage		56.16V
Charge Current		100A
Discharge Voltage Range		45.6V~56.16V
Discharge Current		100A
Communication Mode		CAN/RS485
Working Temperature	Charge	0°C~55°C
	Discharge	-20°C~55°C
Storage Temperature	Short Term (within 1 month)	-10°C~45°C
	Long Term (within 1 year)	0°C~35°C
Storage Humidity		<95% RH
Cell Type		LiFePO ₄ , Lithium Iron Phosphate
Size		H695*W465*D186(mm)
Weight		93.5KG (Wall Bracket Included)
IP Level		IP21

4 Maintenance

4.1 Recharge Requirements During Storage

Batteries should be stored in temperature between $-10^{\circ}\text{C} \sim +45^{\circ}\text{C}$, and recharged regularly according to the following table with 0.2C (40A) current to 50% SOC after long time storage.

Recharge requirement during storage

Storage Temperature	Storage Relative Humidity	Storage Time	SOC
Below -10°C	/	Not Allowed	/
$-10\sim 0^{\circ}\text{C}$	5%~70%	≤ 1 months	$30\% \leq \text{SOC} \leq 60\%$
$0\sim 25^{\circ}\text{C}$	5%~70%	≤ 12 months	$30\% \leq \text{SOC} \leq 60\%$
$25\sim 35^{\circ}\text{C}$	5%~70%	≤ 6 months	$30\% \leq \text{SOC} \leq 60\%$
$35\sim 45^{\circ}\text{C}$	5%~70%	≤ 1 months	$30\% \leq \text{SOC} \leq 60\%$
Above 45°C	/	Not Allowed	/

4.2 Recharge Requirements When Over Discharged

Please recharge over discharged (90% DOD) batteries according to the following table, otherwise over discharged battery will be damaged.

Recharge requirement when battery is over discharged

Storage Temperature	Storage Time	Note
$-10\sim 25^{\circ}\text{C}$	≤ 15 days	Battery disconnected from PCS
$25\sim 45^{\circ}\text{C}$	≤ 7 days	
$-10\sim 45^{\circ}\text{C}$	< 12 hours	Battery connected to PCS

Attention: Disposal of batteries should follow local regulations.